

THREAD GAGING REFERENCE GUIDE

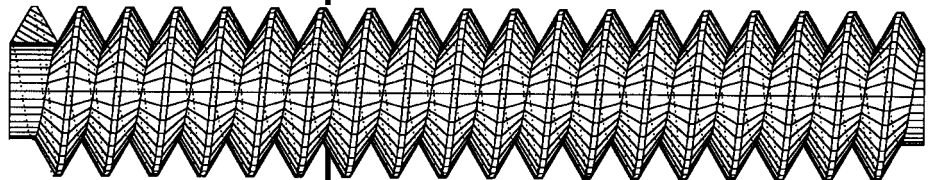
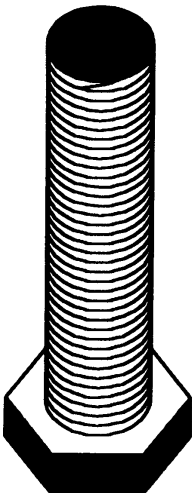
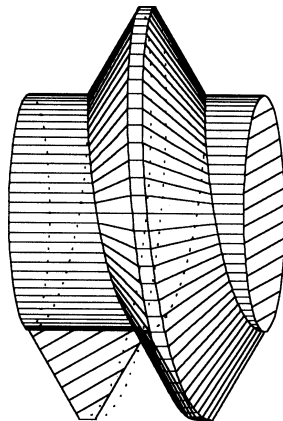
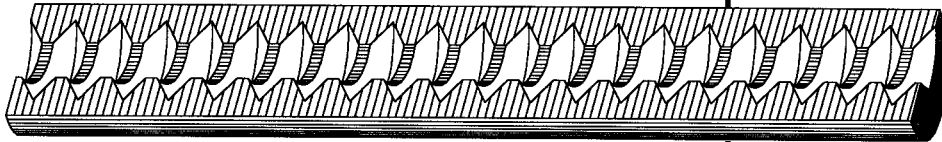

Distributed by:
Gage Crib Worldwide Inc
6701 Old 28th St SE, Suite B
Grand Rapids, MI 49546-6937 USA
Phone: 001.616.954.6581
Web: www.gagecrib.com

Know your threads, inside-out.

**SECTION 1:**

Fundamentals of Screw Thread Technology 4 - 7

SECTION 2:

Definitions and Terminology 8 - 11

SECTION 3:

Gage Design Contacts 12 - 13

SECTION 4:

Technical Considerations 14 - 23

SECTION 5:

Plating, Metric and RFQ 24 - 27

Distributed by:
Gage Crib Worldwide Inc
6701 Old 28th St SE, Suite B
Grand Rapids, MI 49546-6937 USA
Phone: 001.616.954.6581
Web: www.gagecrib.com

Screw Thread Designation

EXAMPLE: .3125 - 24 UNJF - 3A (B)

- .3125 = Nominal Diameter = Maximum Major Diameter
- 24 = Number of threads per inch
- UN = Unified National (60° – V-thread)
- J = Controlled root radius — High Strength
(Minor diameter increased from UN to UNJ.)
- F = Fine thread series
- 3 = Thread class
- A = External thread
- B = Internal thread

Distributed by:
 Gage Crib Worldwide Inc
 6701 Old 28th St SE, Suite B
 Grand Rapids, MI 49546-6937 USA
 Phone: 001.616.954.6581
 Web: www.gagecrib.com

Screw Thread Assembly

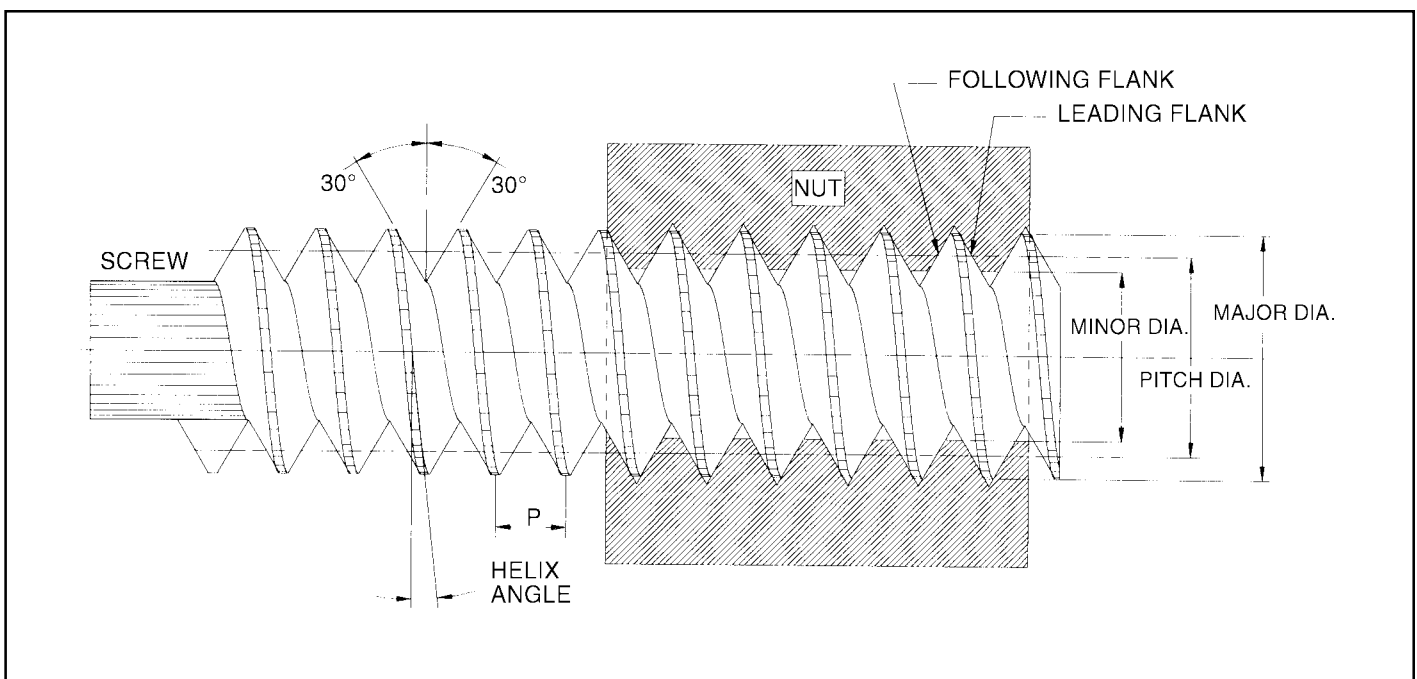

Functional Diameter Size

Pitch Diameter Size + Variations of Thread Elements and Characteristics = Functional Diameter Size

The Functional diameter size is the Pitch diameter size plus the cumulative effect of variations in lead, (including uniformity of helix) flank angle, taper, and roundness. The Functional size is the measured value of the maximum material size of either a product internal or external screw thread.

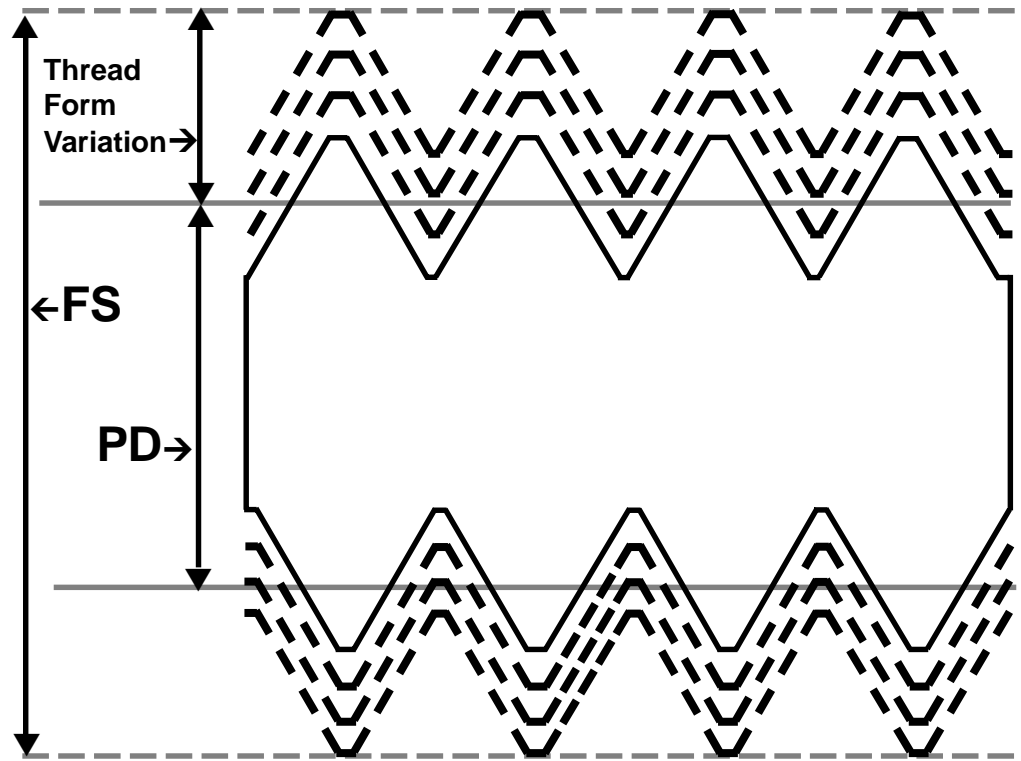

Pitch Diameter Size

The Pitch diameter size is defined as the diameter of a cylinder that passes through the thread profile of either a product internal or external screw thread to make the widths of thread ridge and thread groove equal on both sides of the thread. The Pitch diameter is the measured value of the minimum material limit of size of either a product internal or external screw thread.

Width of Thread Ridge = Width of Thread Groove

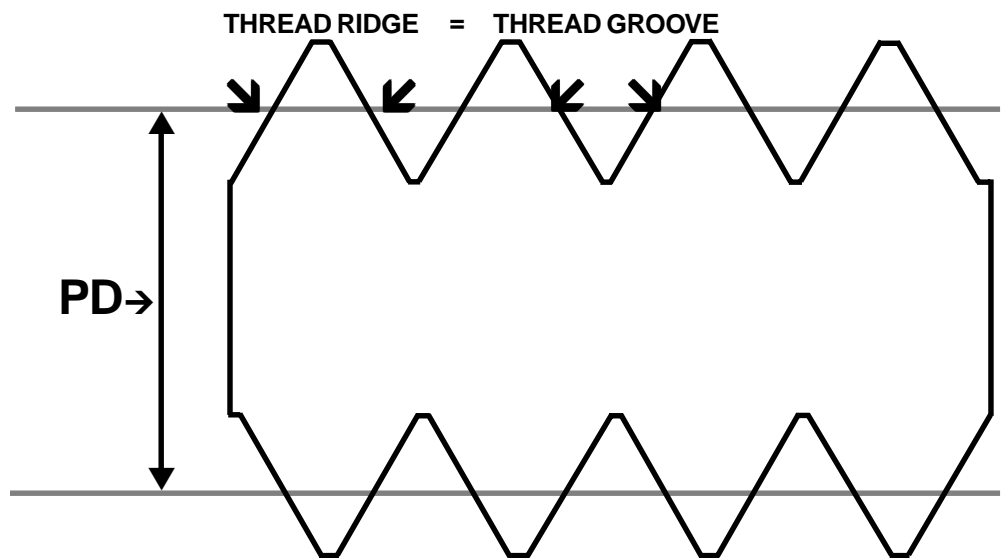

Reference Federal Standard H28/20 – Systems of Gaging

◆ 5.1.3. SYSTEM 21. – GO/NO GO GAGING

5.1.3.1. System 21 provides for interchangeable assembly with functional size control at the maximum material limits within the length of standard gaging elements; and also control of characteristics identified as NOT-GO functional diameters or as HI (Internal) and LO (External) functional diameters. These functional gages provide some control at the minimum material limit when there is little variation in thread form characteristics such as lead, flank angle, taper and roundness.

◆ 5.1.4 SYSTEM 22. – VARIABLES INDICATING TYPE GAGING

5.1.4.1. System 22 provides for interchangeable assembly with functional size control at the maximum material limits within the length of standard gaging elements; and also control of the minimum material size limits over the length of the full thread. Other thread characteristics such as lead, flank angle, taper and roundness variations are confined within these limits with no specific control of their magnitudes. For UNJ and MJ external threads, control is also provided for the thread root radius and rounded root minor diameter.

◆ 5.1.5 SYSTEM 23. – SAFETY CRITICAL

◆ 5.2 ACCEPTABILITY.

Screw thread acceptability criteria are in accordance with Section 6 of ASME B1.3M-1992. Also see subsection 5.7.

Other Reference Standards

◆ **ASME B1.1** – Unified Inch Screw Threads.

◆ **ASME B1.2** – Gages and Gaging for Unified Inch Screw Threads.

◆ **ASME B1.3M** – Screw Thread Gaging Systems for Dimensional Acceptability – Inch and Metric Threads (UN, UNR, UNJ, M and MJ).

Distributed by:
Gage Crib Worldwide Inc
6701 Old 28th St SE, Suite B
Grand Rapids, MI 49546-6937 USA
Phone: 001.616.954.6581
Web: www.gagecrib.com

Thread Class

.250 - 20 UNC - Class?

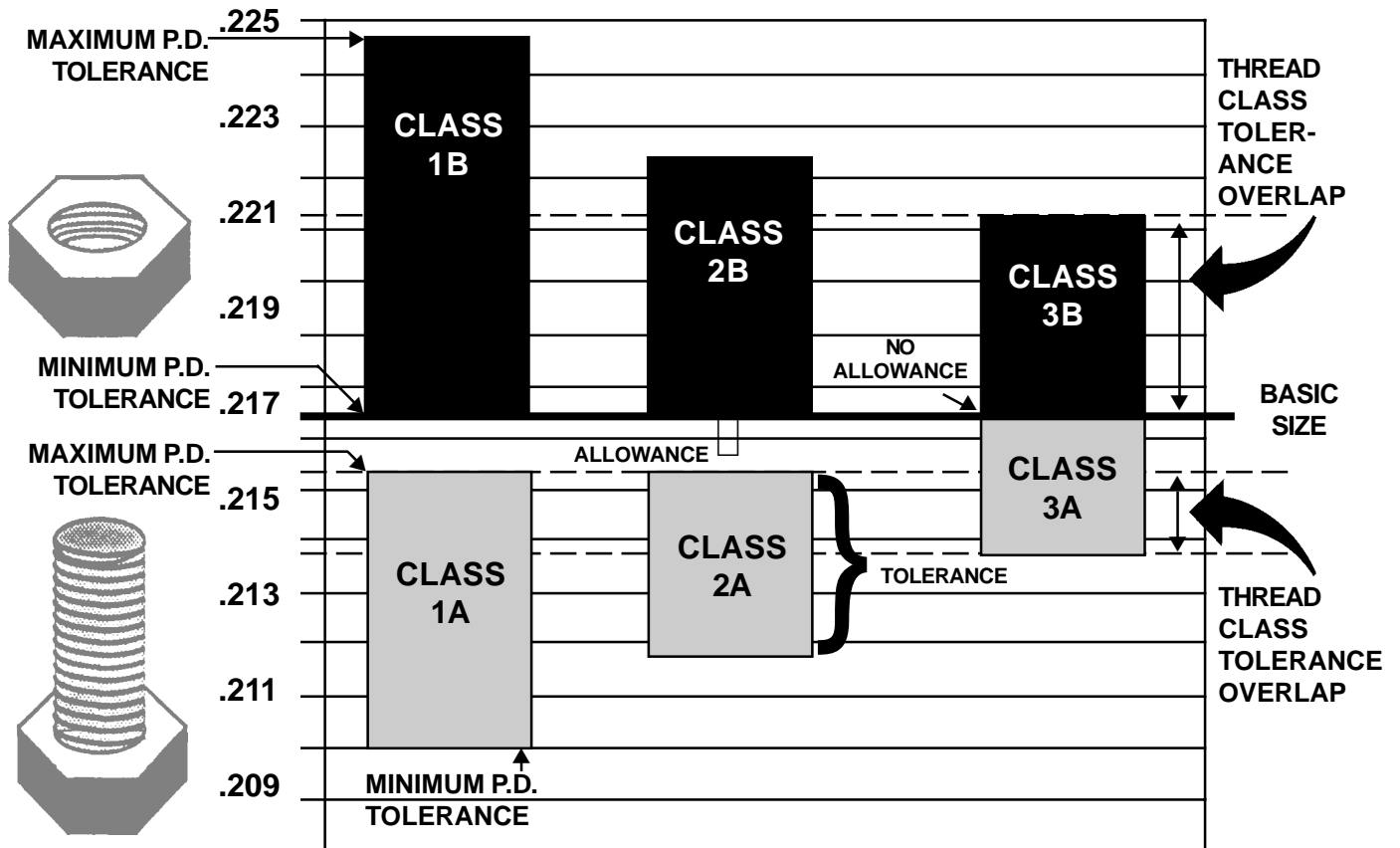

Classes of threads are differentiated by the amount of tolerance and allowance specified. Indicating gaging is typically mastered at maximum material condition. This is the minimum Pitch diameter tolerance limit for I.D. threads and the maximum Pitch diameters tolerance limit for O.D. threads.

Distributed by:
 Gage Crib Worldwide Inc
 6701 Old 28th St SE, Suite B
 Grand Rapids, MI 49546-6937 USA
 Phone: 001.616.954.6581
 Web: www.gagecrib.com

FIGURE 1

Screw Thread

The Screw Thread is a ridge, usually of uniform section and produced by forming a groove as a helix on the external or internal surface of a cylinder, or as a conical spiral on the external or internal surface of a cone. A screw thread formed on a cylinder is known as a straight or parallel thread, to distinguish it from a tapered thread that is formed on a cone.

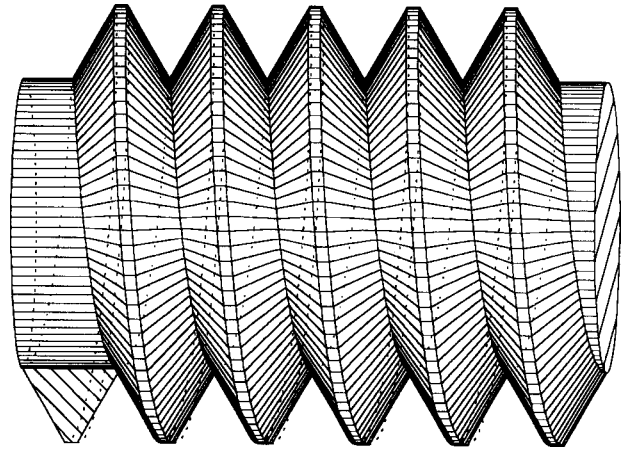

FIGURE 2

Thread

A thread is a portion of a screw thread encompassed by one ridge wrapped around a cylinder or cone for one complete turn.

Single Start Thread

A single start thread is one having one ridge wrapped around a cylinder or cone for the total length.

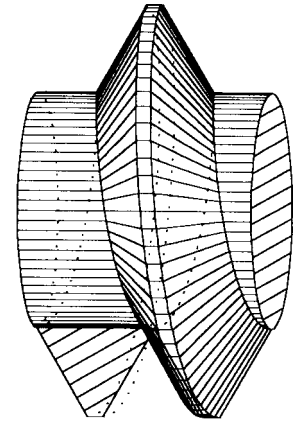

FIGURE 3

Multiple-Start Thread

A multiple-start thread is one that has two or more ridges wrapped around a cylinder or cone for the total length.

External Thread

An external thread is on a cylindrical or conical external surface (reference Figures 1, 2 and 3).

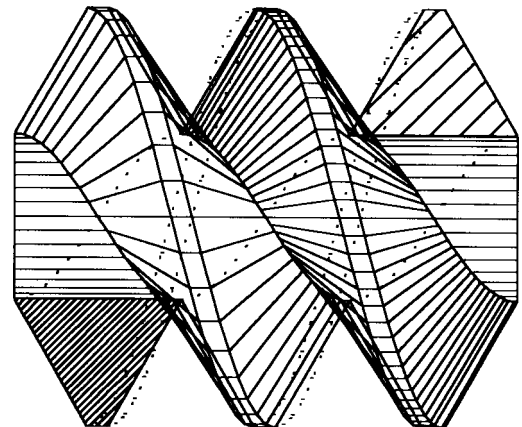
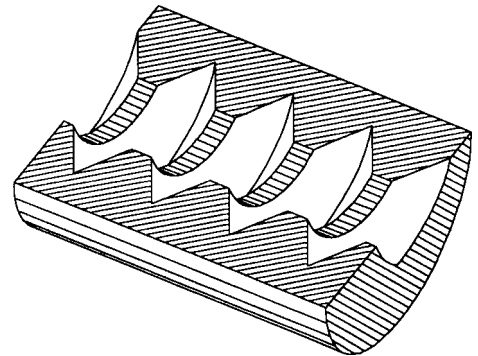
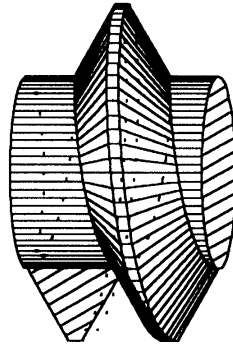

FIGURE 4**Internal Thread**

An internal thread is on a cylindrical or conical internal surface.

**FIGURE 5****Right-Hand Thread**

A thread is a right-hand thread if, when viewed axially, it winds in a clockwise and receding direction. A thread is considered right-hand unless specifically shown otherwise.

**FIGURE 6****Left-Hand Thread**

A thread is a left-hand thread if, when viewed axially, it winds in a counterclockwise and receding direction. All left-hand threads are designated LH.

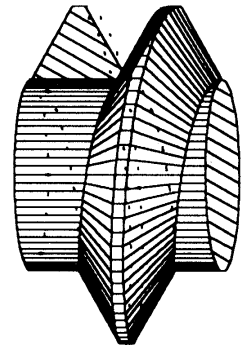
**FIGURE 7****Flank of Thread**

The flank (or side) of the ridge. The flank surface intersection with an axial plane is theoretically a straight line.

Crest of Thread

The crest is that surface of the thread that joins the flank of the thread and is farthest from the cylinder or cone from which the thread projects.

Root of Thread

The root is that surface of the thread that joins the flanks of adjacent thread forms and is identical with or immediately next to the cylinder or cone from which the thread projects.

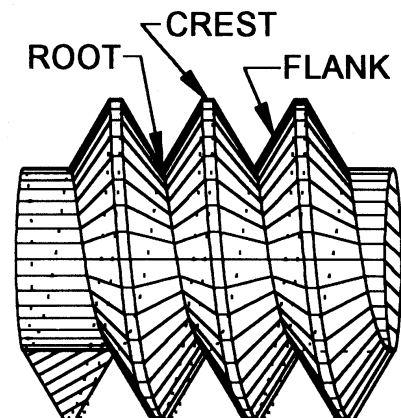

Maximum Material Condition

The condition where the product screw thread contains the maximum amount of material.

Minimum Material Condition

The condition where the product screw thread contains the minimum amount of material.

Tolerance

The total amount of variation permitted for the size of a dimension. It is the difference between the maximum limit of size and the minimum limit of size for a given thread size.

Allowance

The difference between the design (maximum material) size and the basic size.

Basic Size

The basic size is that size from which the limits of size are derived by the application of allowances and tolerances.

Design Size

The design size is the basic size with allowance applied, from which the limits of size are derived by the application of tolerance. If there is no allowance, the design size is the same as the basic size.

Nominal Size

The nominal size is the designation that is used for general identification of the diameter.

Thread series

Thread series are groups of diameters/pitch combinations distinguished from each other by the number of threads per inch applied to specific diameters.

Classes of Thread

Classes of threads are distinguished from each other by the amount of tolerance or tolerance and allowance specified.

Pitch

Pitch is not pitch diameter, threads per inch (TPI), nor is it LEAD, but it is the axial distance defined in (x,y) between any point on a thread to the corresponding point on the adjacent thread.

$$\text{Pitch} = \frac{\text{Number of thread starts}}{\text{Number of threads per inch}}$$

Lead

Lead is the axial advance per unit rotation for a given pitch distance. Pitch equals lead when the thread form is ideal.

Major Cylinder

The major cylinder bounds the crest of an external straight thread or the root of an internal straight thread.

Minor Cylinder

The minor cylinder bounds the root of an external straight thread or the crest of an internal thread.

Pitch Cylinder

The pitch cylinder is one of such diameter and location of its axis that its surface would pass through a straight thread in such a manner as to make the width of the thread ridge and the thread groove equal.

Pitch Line

The pitch line is linear and parallel to the center line of the pitch cylinder. Defined where thread ridge and thread groove are equal along the length of the thread.

Thread Axis

The thread axis is the axis of its pitch cylinder.

Actual Size

An actual size is a measured size.

REFERENCE: ASME B1.7M

Distributed by:
Gage Crib Worldwide Inc
6701 Old 28th St SE, Suite B
Grand Rapids, MI 49546-6937 USA
Phone: 001.616.954.6581
Web: www.gagecrib.com

UN GAGE PROFILE CONTACTS

Gage Contact Profile for Functional Diameter Size Measurements

FUNCTIONAL DIAMETER SIZE

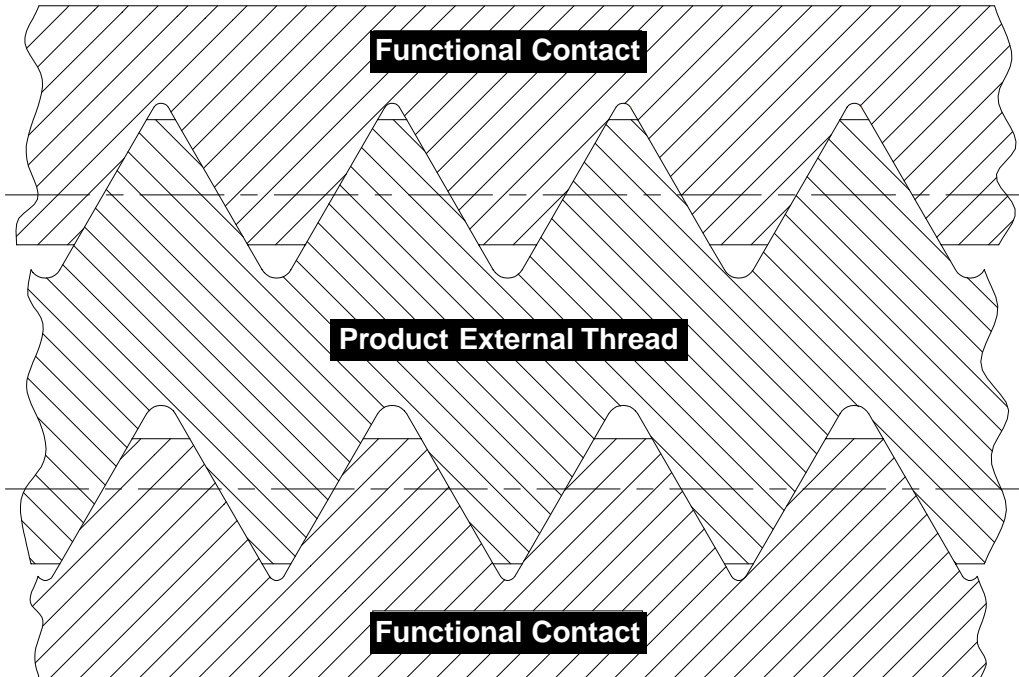

Gage Contact Profile for Pitch Diameter Size Measurements

PITCH DIAMETER SIZE

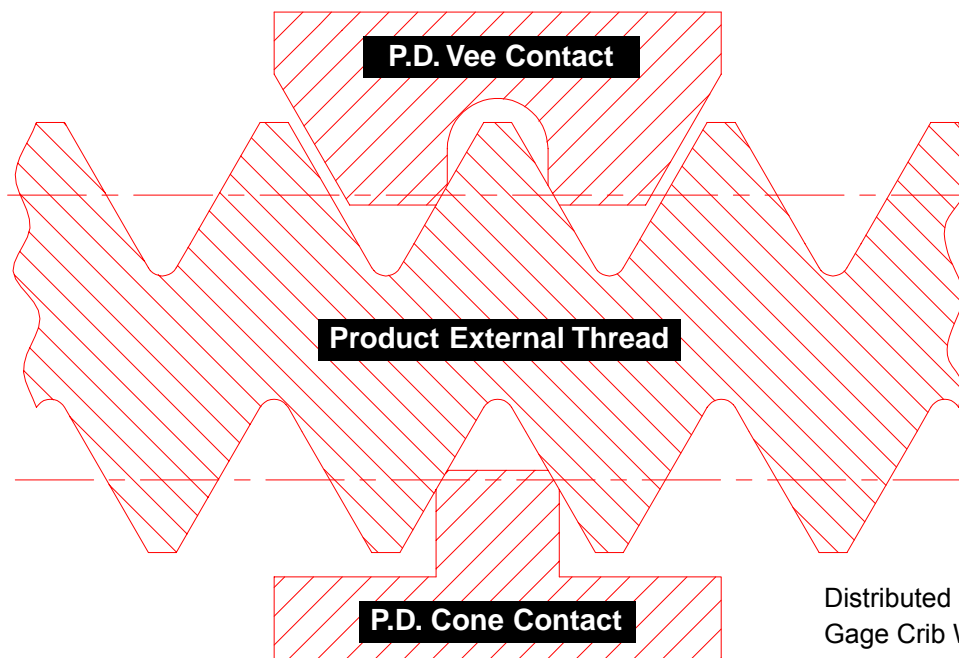

Distributed by:
Gage Crib Worldwide Inc
6701 Old 28th St SE, Suite B
Grand Rapids, MI 49546-6937 USA
Phone: 001.616.954.6581
Web: www.gagecrib.com

INTERNAL UN GAGE PROFILE CONTACTS

Gage Contact Profile for Functional Diameter Size Measurements

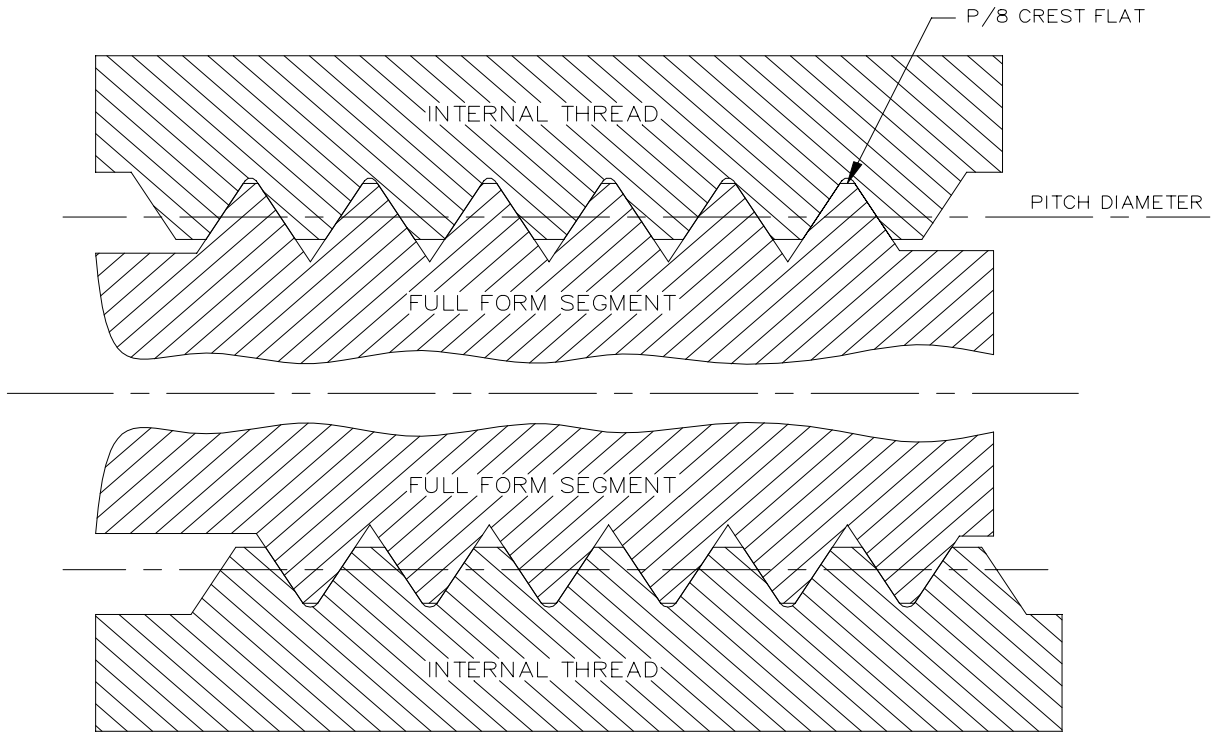

Gage Contact Profile for Pitch Diameter Size Measurements

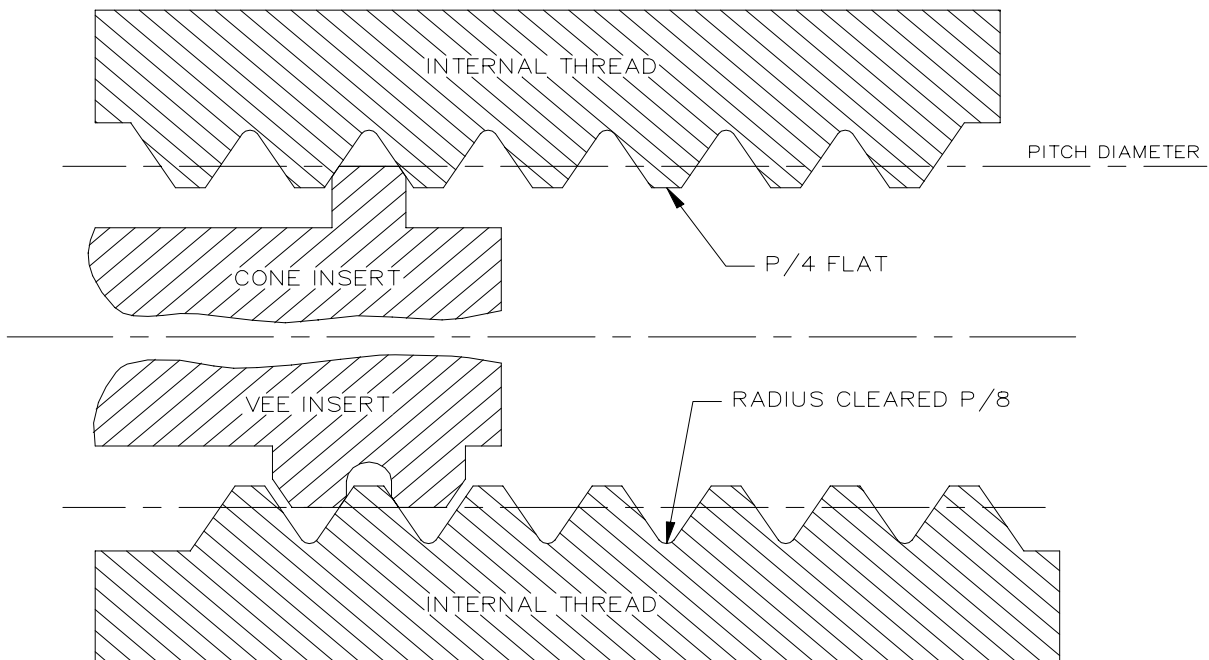

INDICATING THREAD GAGING

Gage Contact Designs

- Pitch Diameter Size – Cone & Vee Rolls (120°)

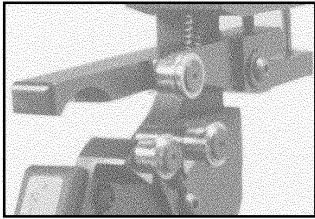

- Functional Diameter Size – Multi-Rib Rolls (120°)

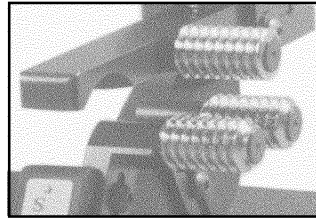

- Functional Diameter Size – Full Form Segments (180°)

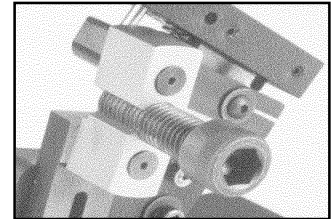

Product Screw Thread Elements & Characteristics

- LEAD
 - Long
 - Short
 - Includes helical deviation "drunk thread"
- FLANK ANGLE
 - Plus
 - Minus
- TAPER
 - Front
 - Back
- OUT OF ROUND
 - Even lobe
 - Odd lobe
- MAJOR DIAMETER
- PITCH DIAMETER
- MINOR DIAMETER

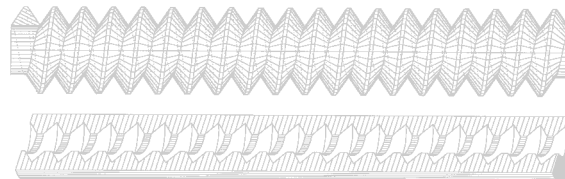

Distributed by:
 Gage Crib Worldwide Inc
 6701 Old 28th St SE, Suite B
 Grand Rapids, MI 49546-6937 USA
 Phone: 001.616.954.6581
 Web: www.gagecrib.com

Anatomy of a UN or UNJ Screw Thread

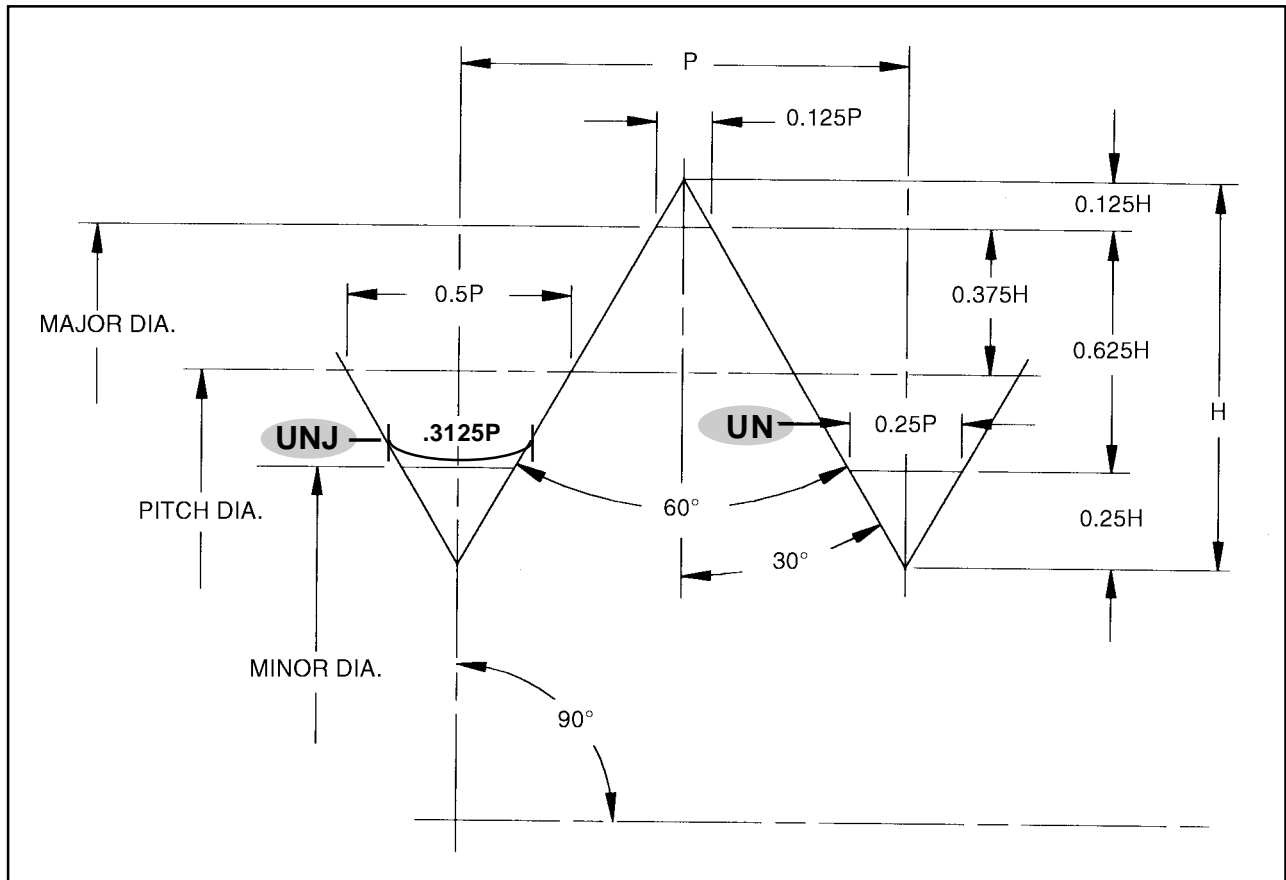

- H = Height of the Fundamental Triangle: $(\cos 30^\circ / \text{TPI})$ or $(\cos 30^\circ \times P)$
- FLANK ANGLES are made up of the two half angles of 30° each for the 60° included angle.
- MAJOR DIAMETER is at $P/8$ or $0.125P$
- PITCH DIAMETER is at $P/2$ or $0.500P$
- MINOR DIAMETER is at $P/4$ or $0.250P$ for UN or UNJ is at $5P/16$ or $.3125P$
- TPI = Number of Threads per Inch
- N = Number of Thread Starts
- P = Pitch $P = N/\text{TPI}$

Distributed by:
 Gage Crib Worldwide Inc
 6701 Old 28th St SE, Suite B
 Grand Rapids, MI 49546-6937 USA
 Phone: 001.616.954.6581
 Web: www.gagecrib.com

VARIATIONS - Lead

Ideal
Lead →

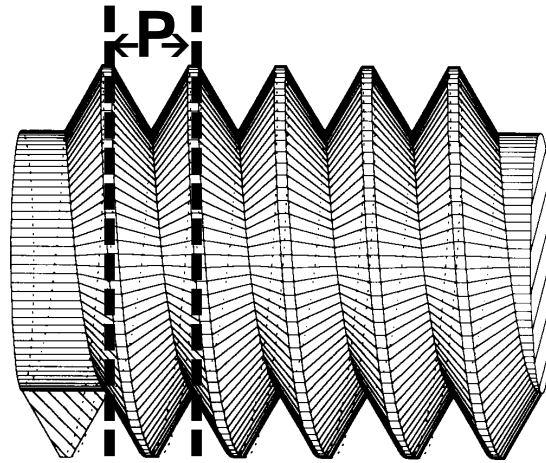

Long
Lead →

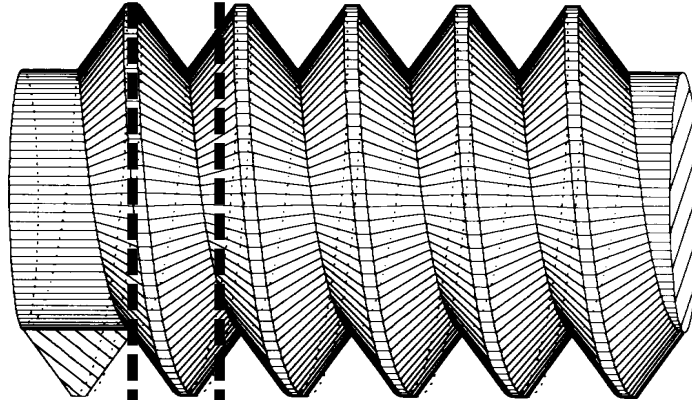

Short
Lead →

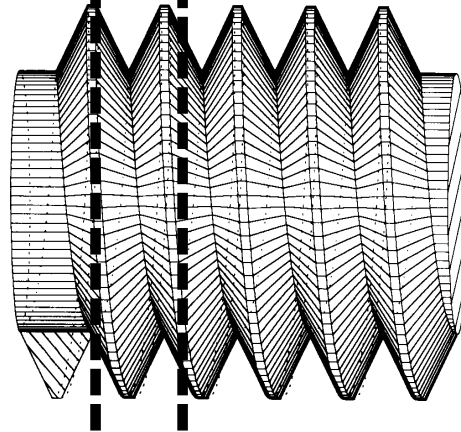

Distributed by:
Gage Crib Worldwide Inc
6701 Old 28th St SE, Suite B
Grand Rapids, MI 49546-6937 USA
Phone: 001.616.954.6581
Web: www.gagecrib.com

Lead is the axial advance per unit rotation for a given pitch distance.

VARIATIONS – Flank Angle

A virtual variation in effective diameter also occurs if the flank angle θ deviates from its specified value.

Distributed by:
 Gage Crib Worldwide Inc
 6701 Old 28th St SE, Suite B
 Grand Rapids, MI 49546-6937 USA
 Phone: 001.616.954.6581
 Web: www.gagecrib.com

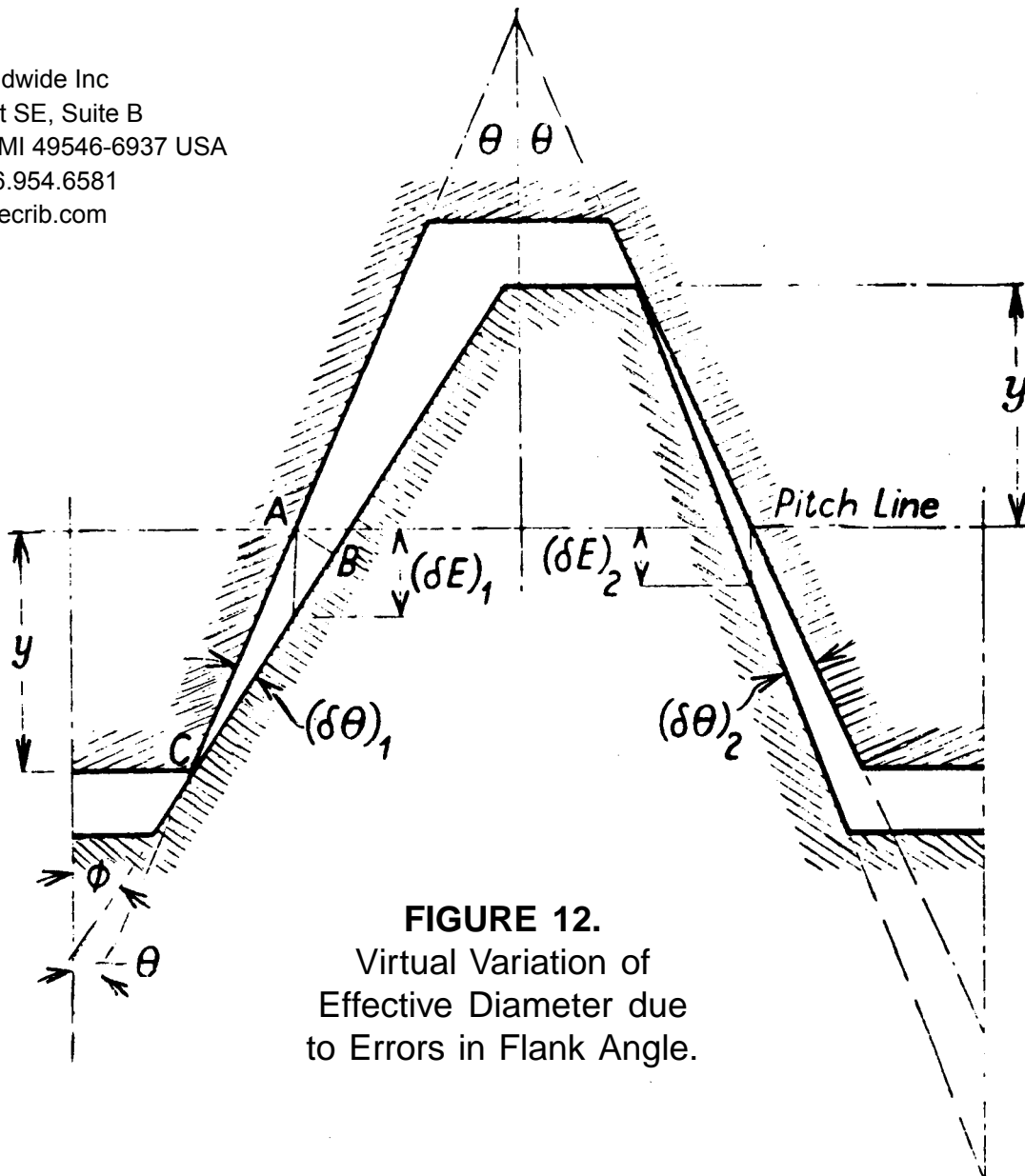
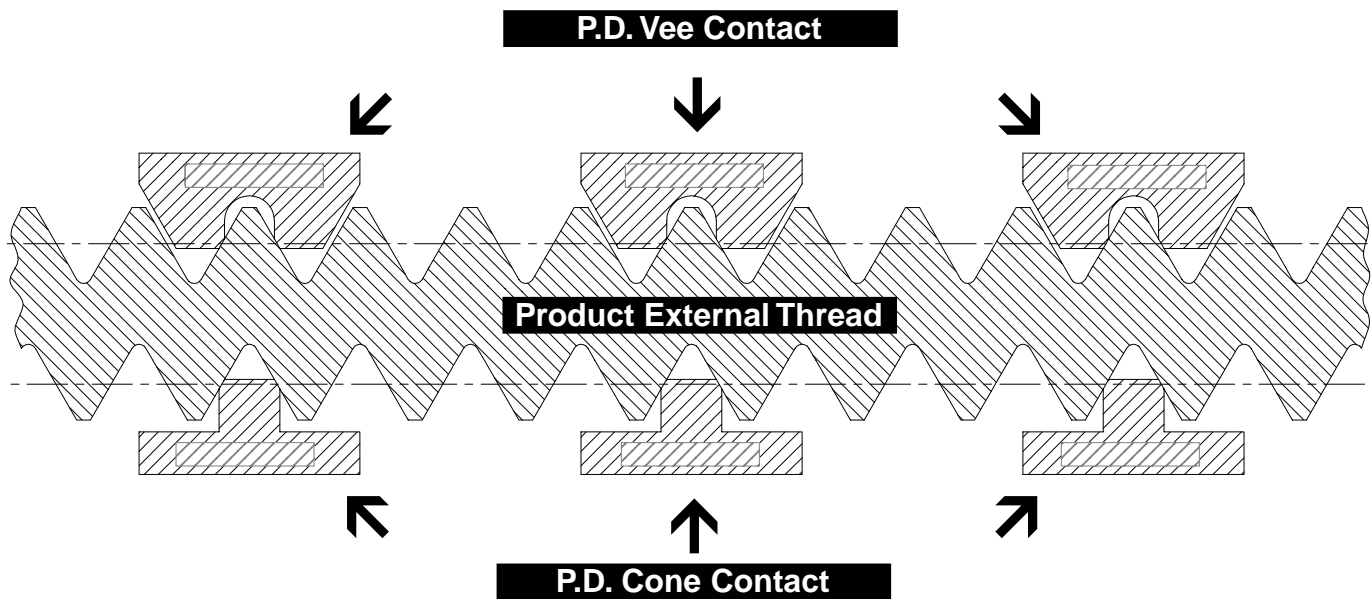

FIGURE 12.
 Virtual Variation of
 Effective Diameter due
 to Errors in Flank Angle.

Reference: Sidders; *Guide to World Screw Threads*, page 212, Figure 12.

DIFFERENTIAL GAGING – Taper



To measure Taper:

Use the Pitch diameter gage (cone and vee) and measure at positions along the length of thread without rotating the part. Any deviation of the dial indicator needle will tell the direction and magnitude of the tapered condition.

Distributed by:
Gage Crib Worldwide Inc
6701 Old 28th St SE, Suite B
Grand Rapids, MI 49546-6937 USA
Phone: 001.616.954.6581
Web: www.gagecrib.com

DIFFERENTIAL GAGING – Out-of-Round

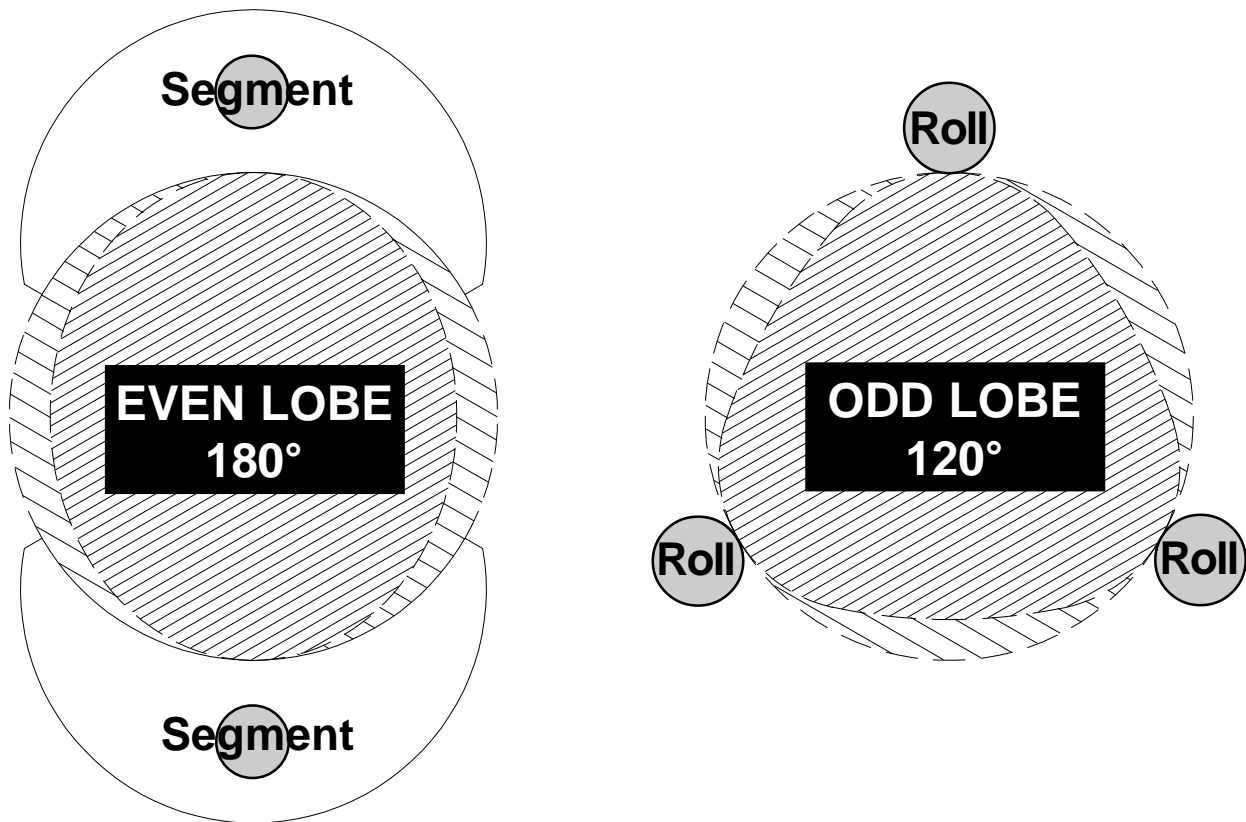

To measure Out-of-Round:

Use the 180° Functional segment to capture the full magnitude of an egg-shaped (even lobe) out-of-round. Use the 120° cone and vee or multi-rib roll contacts for a tri-lobe (odd lobe) out-of-round. When using the Functional diameter gage (multi-rib or segment) rotate the part to observe the largest indicated value for O.D. and the smallest value for I.D. threads. When using the Pitch diameter gage (cone and vee) rotate the part to observe the smallest indicated value for O.D. and the largest value for I.D. threads.

Distributed by:
 Gage Crib Worldwide Inc
 6701 Old 28th St SE, Suite B
 Grand Rapids, MI 49546-6937 USA
 Phone: 001.616.954.6581
 Web: www.gagecrib.com

DIFFERENTIAL GAGING – Lead

Distributed by:
 Gage Crib Worldwide Inc
 6701 Old 28th St SE, Suite B
 Grand Rapids, MI 49546-6937 USA
 Phone: 001.616.954.6581
 Web: www.gagecrib.com

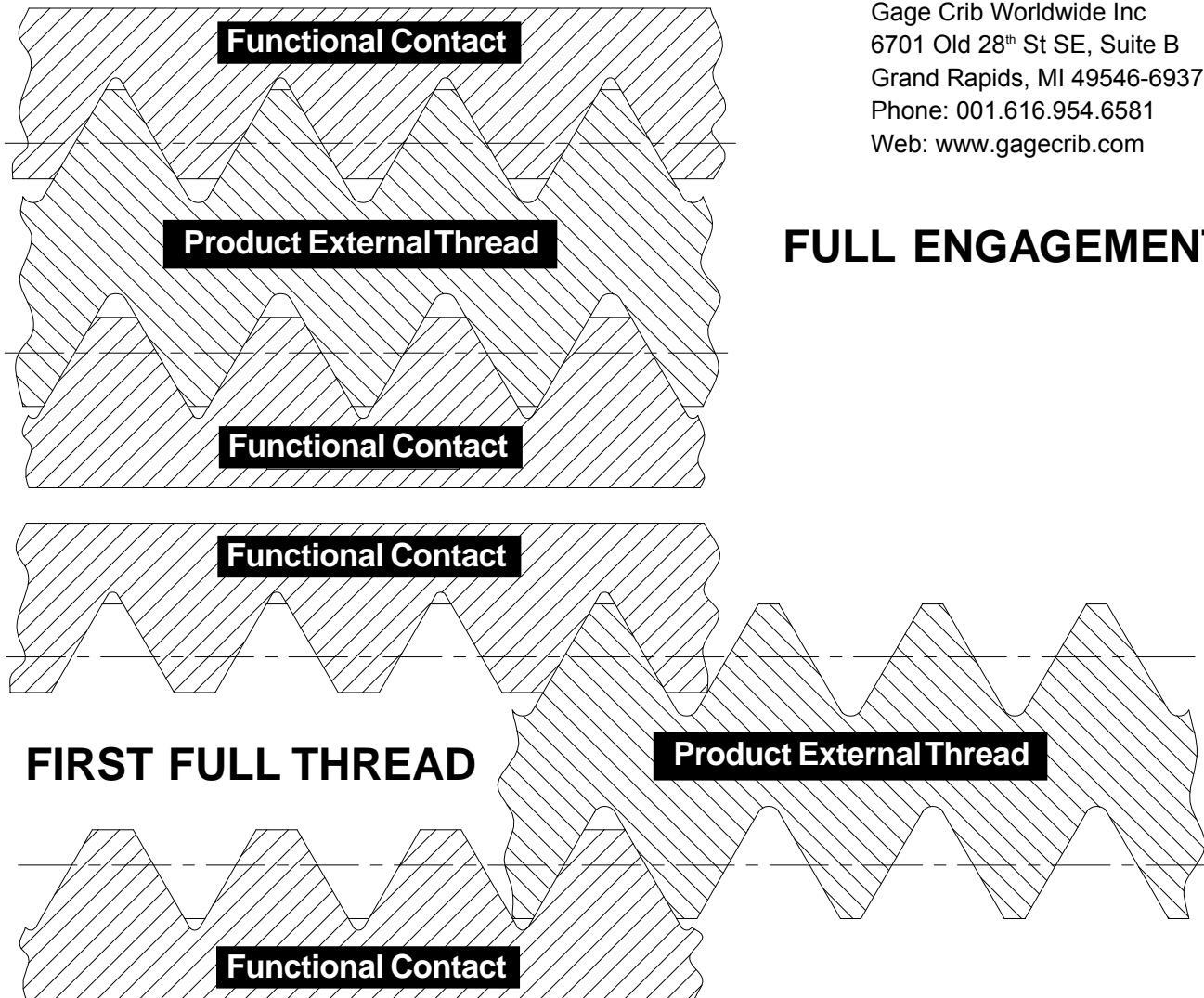

To measure Lead:

Use the 180° Functional segment or the 120° Functional multi-rib roll. Compare the indicated values for product full engagement, then the product's first full thread. The first full thread is usually the second pitch in from the end. The difference between the two indicated values is the total effect of diametral lead variation with respect to the pitch diameter tolerance.

NOTE: Multi-rib (zero lead) functional rolls do not detect a helical deviation (drunk thread).

DIFFERENTIAL GAGING – Flank Angle

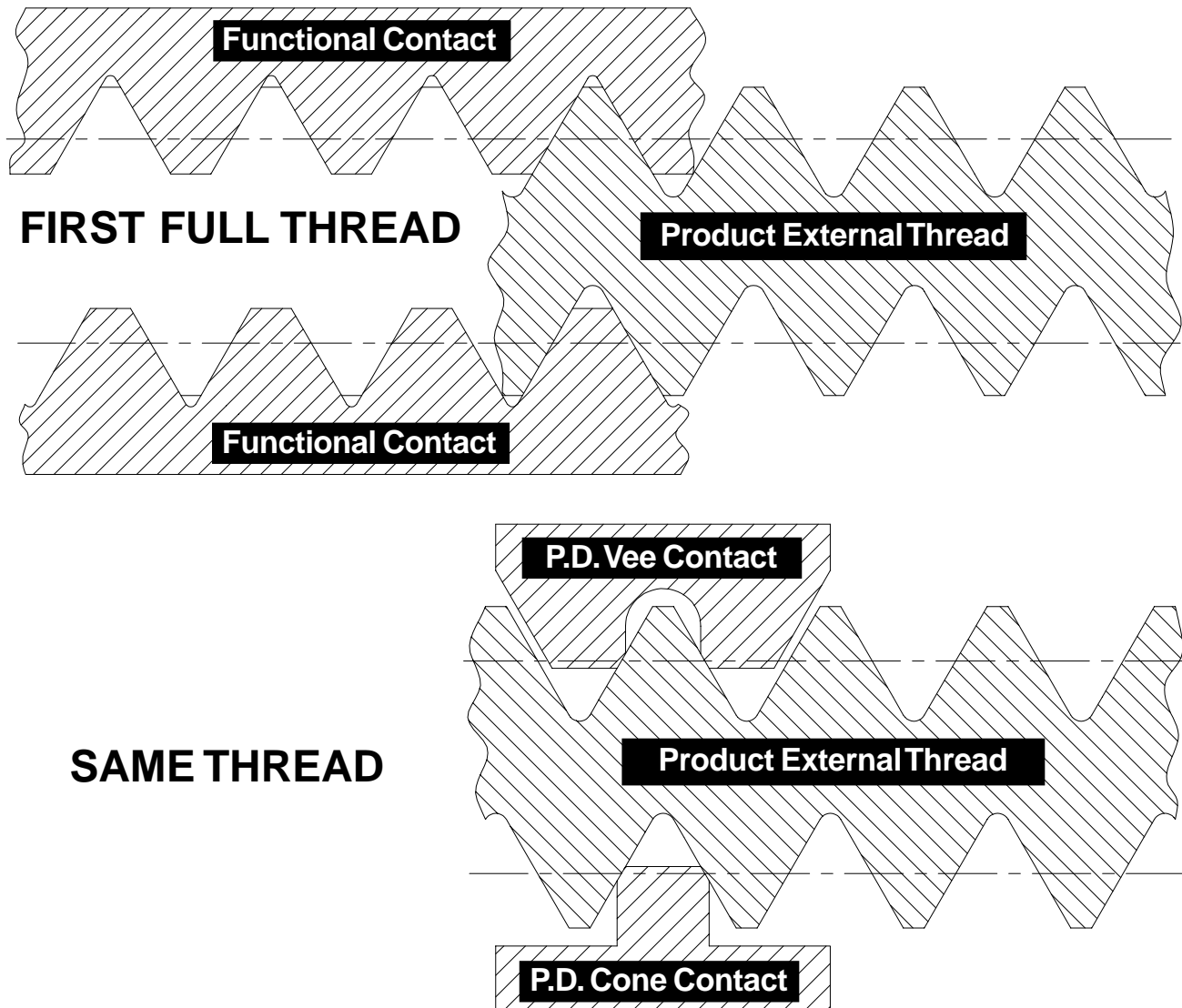

To measure Flank Angle:

Use the Functional gage contact (full form segment or multi-rib roll) and a Pitch diameter gage contact (cone and vee). Engage the product's first full thread functional measurement and compare it with the measurement of the same thread on the Pitch diameter gage. The difference between both indicated values represents the diametral effect of flank angle variation with respect to Pitch diameter tolerance.

DIFFERENTIAL GAGING – System 22

▼ = Maximum PD Tolerance Limit

▽ = Minimum PD Tolerance Limit

① Functional Diameter Size

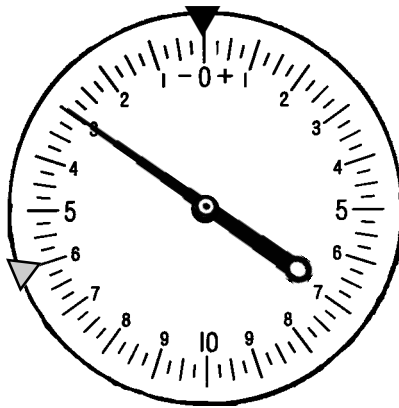

PASS

Pitch Diameter Size

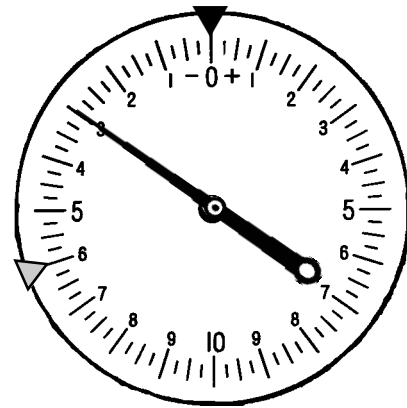

The quality of the thread form is ideal. The thread size is positioned at the mean of the Pitch diameter tolerance. This product passes Systems 21, 22 and 23.

② Functional Diameter Size

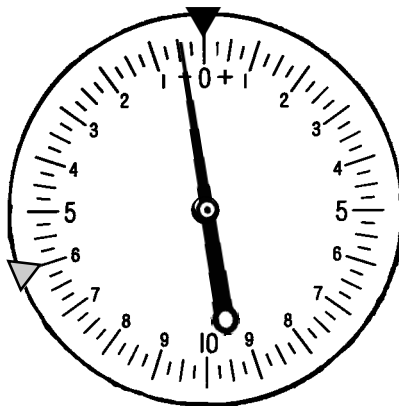

PASS

Pitch Diameter Size

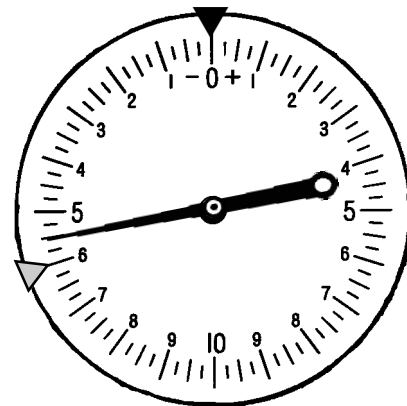

The quality of the thread form is poor. However, it is still within acceptable Pitch diameter tolerance limits. This product passes Systems 21 and 22. May not pass System 23.

Distributed by:
 Gage Crib Worldwide Inc
 6701 Old 28th St SE, Suite B
 Grand Rapids, MI 49546-6937 USA
 Phone: 001.616.954.6581
 Web: www.gagecrib.com

DIFFERENTIAL GAGING – System 22

▼ = Maximum PD Tolerance Limit

▽ = Minimum PD Tolerance Limit

③ *Functional Diameter Size*

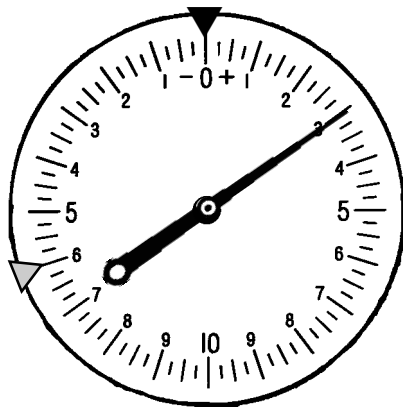

FAIL

Pitch Diameter Size

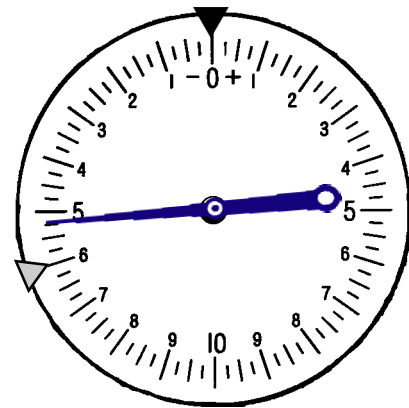

The quality of the thread form is poor. Functional diameter size has exceeded the maximum material limit. This product may not assemble. Product fails Systems 21, 22 and 23.

④ *Functional Diameter Size*

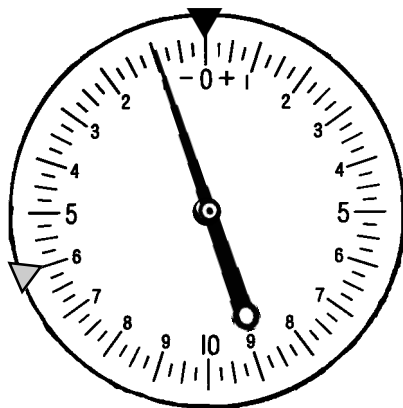

FAIL

Pitch Diameter Size

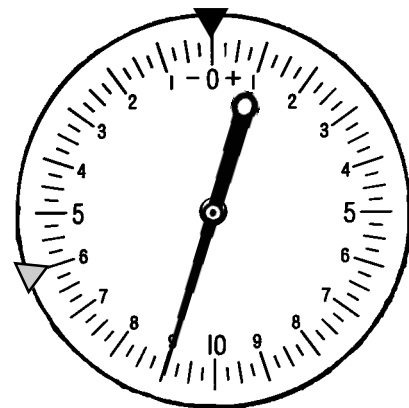

The quality of the thread form is poor. Pitch diameter size has exceeded minimum material limit. This product fails Systems 22 and 23, but may pass System 21.

Distributed by:
 Gage Crib Worldwide Inc
 6701 Old 28th St SE, Suite B
 Grand Rapids, MI 49546-6937 USA
 Phone: 001.616.954.6581
 Web: www.gagecrib.com

Effect on Pitch Diameter with respect to the addition of Plating and Coating Normal to Surface

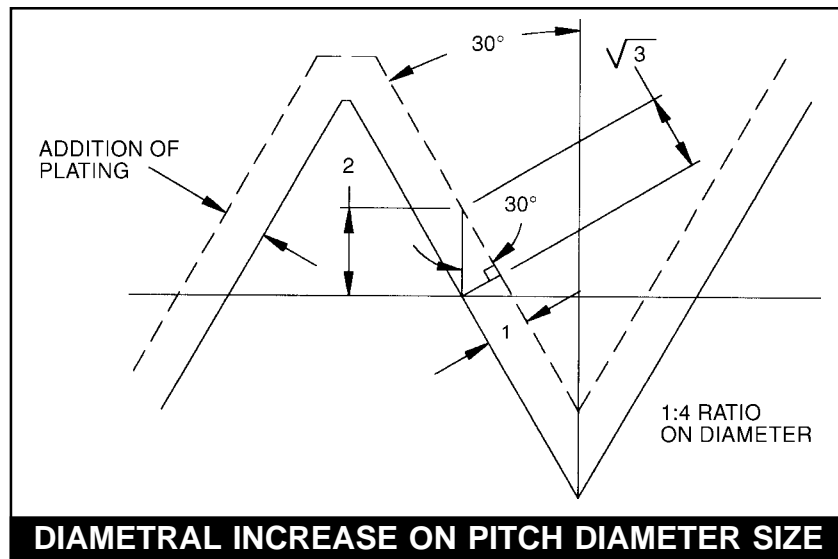

Effect on Functional Size with respect to the addition of Plating and Coating on Lead Variation

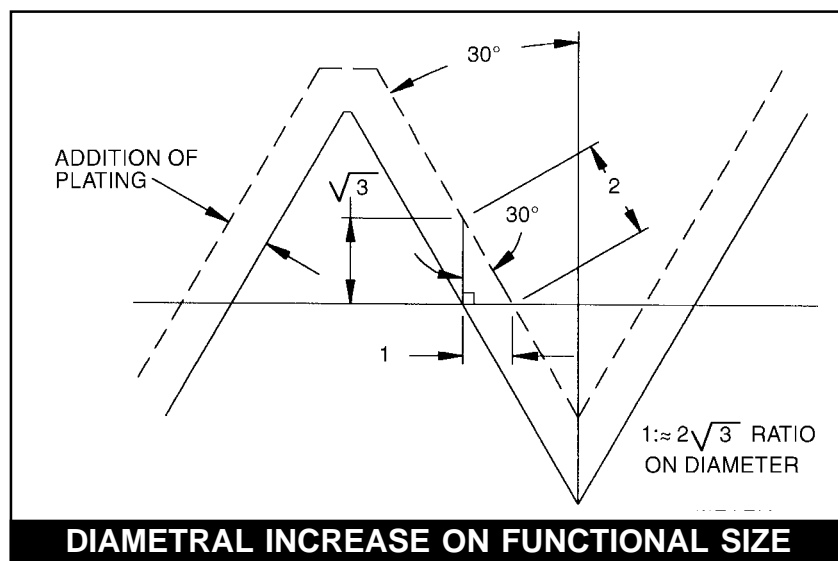

ISO Metric Threads

ISO Basic Designations

SIZE is designated by letter M
 followed by NOMINAL SIZE & PITCH (both in mm)
 separated by sign X.

EXAMPLE: M16X2

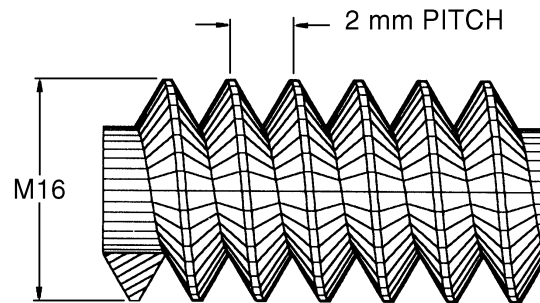

METRIC THREAD SIZE	
M1.6X0.35	
M1.8X0.35	
M2X0.4	
M2.2X0.45	
M6X1	
M7X1	
M8X1.25	Coarse
M8X1	Fine
M16X2	Coarse
M16X1.5	Fine
M18X2.5	Coarse
M18X1.5	Fine

To convert MM Pitch to TPI

$$25.4/\text{Pitch} = \text{TPI}$$

EXAMPLES:

$$2 \text{ mm} = 12.70 \text{ TPI}$$

$$.35 \text{ mm} = 72.57 \text{ TPI}$$

Distributed by:
 Gage Crib Worldwide Inc
 6701 Old 28th St SE, Suite B
 Grand Rapids, MI 49546-6937 USA
 Phone: 001.616.954.6581
 Web: www.gagecrib.com

ISO Metric Threads

ISO Product Tolerance Symbols

